

RAD TORQUE SYSTEMS - THERE IS A BETTER WAY



LEADING MANUFACTURER OF ADVANCED TORQUE SYSTEMS



PNEUMATIC



BATTERY



ELECTRONIC



ELECTRIC



PNEUMATIC SERIES

Classic2
High Speed3
Gen-X4
Wheel Nut Bolting5



BATTERY SERIES

B Series6



ELECTRONIC SERIES

E Series7-8
Controllers9



ELECTRIC SERIES

V Series10



ACCESSORIES

Reaction Arms11
Nose Extensions12
Torque Analyzers13

COMPANY PROFILE14



RAD[®] CLASSIC SERIES

RAD[®] CLASSIC SERIES torque wrenches offer a reliable and dependable solution for the installation and removal of heavy-duty fasteners in a variety of industries that require accuracy, power, and safety.

- ✓ *PATENTED planetary gear reduction drive system delivering one of the highest power-to-weight ratios of any pneumatic controlled bolting system*
- ✓ *Smooth continuous flow of controlled torque eliminating destructive hammering*
- ✓ *Lightweight ergonomic pistol grip design reducing operator strain and injury; resulting in increased productivity*
- ✓ *Controlled torque - accuracy of +/-5%, and repeatability of +/-2%*



Unmatched accuracy through precision engineering and design



RAD[®] 350SL



RAD[®] 1800NG

CLASSIC SERIES DIMENSIONS

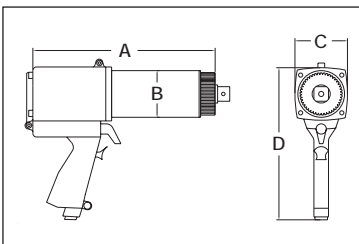

All RAD[®] Pneumatic Series tools include reaction arm, 12' hose & fittings and all new ergonomic regulator cage



CE RAD[®] 50

PART NUMBER	TOOL MODEL	DRIVE SIZE	TORQUE (ft. lbs.)		RPM	WEIGHT (lbs.)	NOISE LEVEL	DIMENSION A	DIMENSION B	DIMENSION C	DIMENSION D
			LOW	HIGH							
12316	350SL	0.75"	50	350	65	6.0	80 db	6.6"	2.4"	2.75"	8.75"
12321	550SL	0.75"	100	550	35	6.6	80 db	7.3"	2.4"	2.75"	8.75"
12329	800NG	0.75"	150	800	30	9.5	85 db	7.75"	2.84"	3.3"	9.5"
12338	1400NG	1.0"	300	1400	15	12.5	85 db	9.0"	3.0"	3.3"	9.5"
12342	1800NG	1.0"	500	1800	13	12.5	85 db	9.0"	3.0"	3.3"	9.5"
12348	30	1.0"	1000	3000	14	20.5	85 db	13.2"	3.1"	3.7"	10.4"
12357	50	1.5"	1500	5000	8	28.0	85 db	13.9"	4.0"	3.7"	10.4"

Visit our website for a complete up-to-date list of products.

PNEUMATIC SERIES

RAD® HIGH SPEED SERIES

Introduced to compliment the RAD® classic series torque wrenches, **RAD® HIGH SPEED SERIES** torque wrenches offer the same reliable and dependable solution for the installation and removal of heavy-duty fasteners where accuracy, power, and safety are required. **RAD® HIGH SPEED SERIES** torque wrenches incorporate a precision engineered *high speed* gear box designed for faster run down on time sensitive bolting applications reaching speeds as high as 300 rpm.



Extreme torque with high RPM productivity



RAD® 350SL-2



RAD® 800NG-2



RAD® 1400NG-2

HIGH SPEED SERIES DIMENSIONS

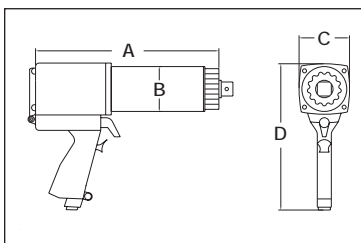

Torque (Ft. Lb.)	Pressure (PSI)
200	30
250	37
300	45
350	52
400	60
450	68
500	76
550	85

All RAD® Pneumatic Series tools include a laminated torque/PSI chart, assuring maximum accuracy and performance

PART NUMBER	TOOL MODEL	DRIVE SIZE	TORQUE (ft. lbs.) LOW	TORQUE (ft. lbs.) HIGH	RPM	WEIGHT (lbs.)	NOISE LEVEL	DIMENSION A	DIMENSION B	DIMENSION C	DIMENSION D
12317	350SL-2	0.75"	100	350	300	8.3	80 db	9.0"	2.4"	2.75"	8.75"
12322	550SL-2	0.75"	200	550	170	9.0	80 db	9.5"	2.4"	2.75"	8.75"
12330	800NG-2	0.75"	300	800	170	11.5	85 db	9.75"	2.84"	3.3"	9.5"
12339	1400NG-2	1.0"	500	1400	69	16.0	85 db	11.5"	3.0"	3.3"	9.5"
12343	1800NG-2	1.0"	700	1800	53	16.0	85 db	11.5"	3.0"	3.3"	9.5"
12349	30-2	1.0"	1400	3000	55	25.0	85 db	15.7"	3.1"	3.4"	10.4"

Visit our website for a complete up-to-date list of products.

Accuracy of +/-5%, Repeatability of +/-2%

RAD[®] GEN-X SERIES

Precision design and engineering has brought about the next generation in torque wrenches – the **RAD[®] GEN-X SERIES**.

Designed for extreme duty use in a variety of industries worldwide, **RAD[®] GEN-X SERIES** torque wrenches offer:

- ✓ The ultimate in power-to-weight ratio
- ✓ Wide torque range to suit multiple applications
- ✓ Unmatched reliability delivered by one of the most advanced engineered gear boxes on the market



Extreme Duty Torque Wrenches for Heavy Duty Applications



RAD[®] 10GX



RAD[®] 25GX



CE RAD[®] 34GX

GEN-X SERIES DIMENSIONS

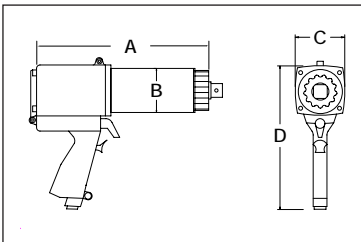

All RAD[®] Pneumatic Series tools include reaction arm, 12' hose & fittings and all new ergonomic regulator cage

PART NUMBER	TOOL MODEL	DRIVE SIZE	TORQUE (ft. lbs.)		RPM	WEIGHT (lbs.)	NOISE LEVEL	DIMENSION A	DIMENSION B	DIMENSION C	DIMENSION D
			LOW	HIGH							
12814	7GX	0.75"	100	700	30	8.0	80 db	9.0"	2.5"	2.75"	9.0"
12818	10GX	0.75"	200	1000	20	8.0	80 db	9.0"	2.5"	2.75"	9.0"
12377	25GX	1.0"	500	2500	9	13.5	85 db	9.7"	3.05"	3.3"	9.5"
12356	34GX	1.0"	1000	3400	12	20.0	85 db	12.8"	3.4"	3.7"	10.4"
15328	New 60DX	1.5"	2000	6000	6.6	27.5	85 db	13.5"	4.5"	4.0"	10.9"
12383	85GX	1.5"	3000	8500	4.5	38.5	85 db	17.0"	4.75"	5.0"	11.0"

Visit our website for a complete up-to-date list of products.

Accuracy of +/-5%, Repeatability of +/-2%

RAD® WHEEL NUT BOLTING SERIES

The **RAD® WHEEL NUT BOLTING SERIES** and the **RAD® OTR MINING SERIES** were designed with one job in mind - **wheel nut bolting** for light and heavy duty applications where torque control is a must. The extended nose with available custom reaction arms make this tool ideal for reaching wheel nut studs that are recessed where tool clearance is a problem.

- ✓ Extend drive and reaction for safety and ergonomics
- ✓ Removable custom reaction arms designed to fit virtually any wheel configuration



RAD® 7GX-R

Custom Reaction Arms Available

PART NUMBER	TOOL MODEL	DRIVE SIZE	TORQUE (ft. lbs.)		RPM	WEIGHT (lbs.)	NOISE LEVEL	DIMENSION A	DIMENSION B	DIMENSION D	DIMENSION E
			LOW	HIGH							
13495	7GX-R	0.75"	150	700	115	12.0	80 db	14.5"	2.50"	2.75"	9.0"

RAD® OTR MINING SERIES

#1 Choice for Mines Worldwide



GX-R SERIES DIMENSIONS

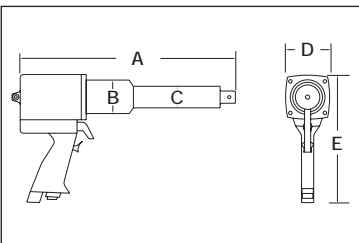

The **RAD® OTR MINING SERIES** of wheel nut bolting systems were developed exclusively for extreme duty maintenance of mining haul trucks from 50-400 ton capacities and front end loaders. The extended nose allows safe access of virtually all wheel configurations found on today's heavy equipment.



RAD® 1400NGX-R



Custom Reaction Arms Available

PART NUMBER	TOOL MODEL	DRIVE SIZE	TORQUE (ft. lbs.)		RPM	WEIGHT (lbs.)	NOISE LEVEL	DIMENSION A	DIMENSION B	DIMENSION C	DIMENSION D	DIMENSION E
			LOW	HIGH								
13478	1400NGX-R	1.0"	300	1400	14	27.5	85 db	21.5"	3.0"	2.0"	3.3"	9.5"
13477	1800NGX-R	1.0"	500	1800	10	27.5	85 db	21.5"	3.0"	2.0"	3.3"	9.5"

Visit our website for a complete up-to-date list of products.

Accuracy of +/-5%, Repeatability of +/-2%

RAD BATTERY SERIES

RAD BATTERY SERIES torque wrenches offer unmatched power, versatility, and reliability. Incorporating our precision engineered gear boxes, their lightweight design makes these tools ideal for any application, especially where compressed air or electricity is not readily available. The **RAD** BATTERY SERIES are available in single speed and high speed models.



Just imagine the freedom....

No Air Lines! No Power Cords! No Hassles!

- ✓ Advanced Patented Gearbox
- ✓ Soft Start Trigger for Safety
- ✓ Ergonomic Pistol Grip Handle
- ✓ Quick Charge 18V Li-Ion Battery
- ✓ Easy View Torque Settings



BATTERY SERIES DIMENSIONS

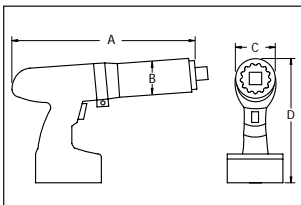

Patent Pending

All B-RAD tools come fully calibrated complete with:

- B-RAD Tool
- Reaction Arm and Retention Ring
- Two 18 volt Batteries
- Battery charger
- Calibration Chart
- Storage Case



PART NUMBER	TOOL MODEL	DRIVE SIZE	TORQUE (ft. lbs.)		WEIGHT (lbs.)	DIMENSION A	DIMENSION B	DIMENSION C	DIMENSION D
			LOW	HIGH					
16191	B-RAD 350	0.75"	100	350	8.4	8.75"	2.4"	2.8"	10.5"
16193	B-RAD 700	0.75"	300	700	9.5	10.0"	2.5"	3.0"	10.25"
16006	B-RAD 700-2	0.75"	300	700	10.6	12.62"	2.5"	3.0"	10.5"
16194	B-RAD 1300	1.0"	500	1300	13.6	11.75"	3.05"	3.0"	10.5"
16195	B-RAD 1300-2	1.0"	500	1300	15.6	13.75"	3.05"	3.0"	10.25"

Visit our website for a complete up-to-date list of products.

RAD® E SERIES

RAD® E SERIES are the world's most advanced electronic pistol grip torque wrenches. They are designed to provide a high degree of accuracy and repeatability using our legendary gear box design and the precision of an electronic motor. Capable of data collection, angle measurement, accuracy of +/-3%, and torque values up to 6000 ft/lbs, **RAD** E SERIES offer an affordable solution for electronic bolting needs.

Precision Bolting Driven by Technology and Design

LIGHTER

Combining the latest advancements in ergonomic design along with an ultra-durable portable carrying case, the E Series torque system is a lightweight alternative to other bolting systems.

FASTER

Compared to other conventional torque systems, such as hydraulic wrenches, the E-RAD electronic torque system decreases tightening times by up to 60% through the delivery of continuous torque, boosting your productivity dramatically and increasing the speed of job completion.

STRONGER

With unsurpassed power-to-weight ratio and our legendary patented gearbox design, E Series tools offer the highest dependability and reliability in the industry.



W
E
C
H
O
N
O
L
O
G
Y
S
E
R
V
I
C
E

- ✓ **Push-button select torque**
Fast and convenient error-free digital single increment torque settings
- ✓ **Lightweight and Ergonomic pistol grip design**
Advanced low-profile handle to reduce operator fatigue and increase productivity
- ✓ **Extremely low noise level only 75db**
World's quietest extreme torque gun, ideal for sensitive environments and standards
- ✓ **LED Green (Pass) or Red (Fail) indicator lights**
Unmistakable visual signal indicates status of torque procedure for maximum accuracy and speed
- ✓ **Data collection capability**
All E Series tools come complete with data collection software allowing traceability of each torque sequence performed



LED lights located on both sides



Integrated Fan Kit



Forward/Reverse Switch

ELECTRIC SERIES DIMENSIONS

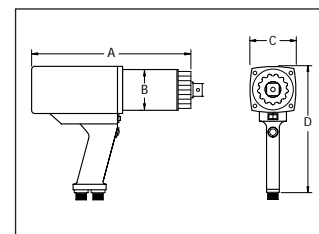

PART NUMBER	TOOL MODEL	DRIVE SIZE	TORQUE (ft. lbs.)		WEIGHT (lbs.)	DIMENSION A	DIMENSION B	DIMENSION C	DIMENSION D
			LOW	HIGH					
14991	E-RAD 700	0.75"	100	700	12	11.75"	2.4"	2.5"	9.5"
12313	E-RAD 1200	1.0"	200	1200	15	12.75"	3.0"	3.25"	9.5"
12314	E-RAD 2000	1.0"	250	2000	18	13.25"	3.0"	3.5"	10.0"
15710	New E-RAD 2500 COMP	1.0"	250	2500	18	14.25"	3.0"	3.0"	7.75"
12703	E-RAD 3000	1.0"	500	3000	23.5	15.5"	3.4"	3.5"	10.0"
13992	E-RAD 4000	1.5"	800	4000	31	16.7"	4.0"	4.0"	10.0"
15952	New E-RAD 6000	1.5"	1500	6000	29	15.5"	4.0"	4.0"	10.0"

Visit our website for a complete up-to-date list of products.

Accuracy of +/-3%

RAD® E SERIES CONTROLLERS AND OPTIONS

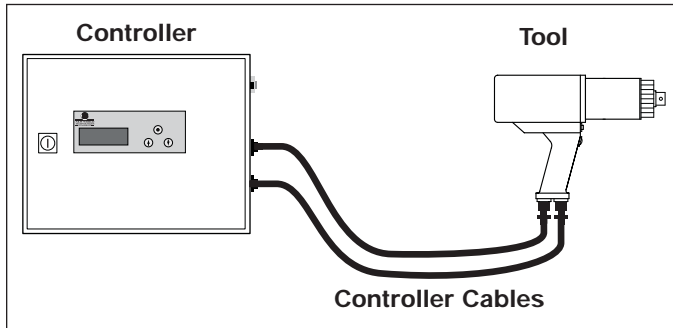

E Series controllers provide the interface for all E-RAD tools. A standard E-Series controller allows the user to dial up and down, using the touch pad, in single digit increments to their desired torque.

Option 1 - Part #13629

- ✓ User has the option to define **torque** settings
- ✓ Defined settings can be stored using an 8 channel selector switch
- ✓ All torque positions can be locked out using a removable key
- ✓ Basic data collection

Option 2 - Part #13630

- ✓ User has the option to define **torque or angle** or **torque and angle** sequence (1 channel)
- ✓ Tool operates as a standard E-RAD when angle is set to zero
- ✓ Basic data collection

Option 3 - Part #13631

- ✓ User has the option to define **torque or angle** or **torque and angle** sequence
- ✓ Defined settings can be stored using an 8 channel selector switch
- ✓ All defined settings can be locked out using a removable key
- ✓ Basic data collection

All E Series tools come fully calibrated complete with:

- E-RAD Tool
- Reaction Arm and Retention Ring
- Controller cables
- Digital Torque Controller
- Operators manual
- E-RADCAL Calibration Software

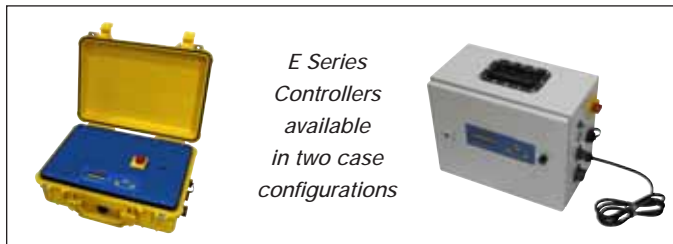

User friendly controls allow for quick torque adjustments. The backlit LCD display with three units of selectable measurement (Ft. /lbs, Nm, Kgf.m) provides optimum visibility and accuracy.

SELECT ONE OF THE FOLLOWING CONTROLLERS

PART NUMBER	DESCRIPTION	CASE TYPE	VOLTAGE	LENGTH DIMENSION	HEIGHT DIMENSION	WIDTH DIMENSION
13632	CONTROLLER	STEEL ASSEMBLY	120	14.9"	11.8"	8"
13626	CONTROLLER	WEATHERPROOF ASSEMBLY	120	18.5"	6.9"	14"
13627	CONTROLLER	STEEL ASSEMBLY	220	14.9"	11.8"	8"
14108	CONTROLLER	WEATHERPROOF ASSEMBLY	220	18.5"	6.9"	14"

SELECT ONE OF THE FOLLOWING CABLE LENGTHS

PART NUMBER	TOOL MODEL	CABLE LENGTH (FT)
10984	CABLE LENGTH FROM CONTROLLER TO TOOL MODEL (standard with tool)	15
11845	CABLE LENGTH FROM CONTROLLER TO TOOL MODEL	20
11846	CABLE LENGTH FROM CONTROLLER TO TOOL MODEL	25

OPTIONS

PART NUMBER	DESCRIPTION	FOR USE WITH
13629	OPTION 1 - SELECTOR SWITCH WITH USER DEFINED TORQUE	ALL E-RAD'S
13630	OPTION 2 - USER DEFINED TORQUE AND ANGLE (1 CHANNEL)	ALL E-RAD'S
13631	OPTION 3 - USER DEFINED TORQUE AND ANGLE (8 CHANNEL)	ALL E-RAD'S
13628	SUPER DUTY FAN KIT	E-RAD 2000 - 4000

Visit our website for a complete up-to-date list of products.

*E-RAD operates in standard mode if no options are selected

S M - R M S - C O N - T R O L - M E C H

RAD® V SERIES

RAD® V SERIES are a new generation of electric torque wrenches used for the installation or removal of heavy duty fasteners where accuracy, power, and safety are required. This series comes without the hassle of air hoses and simply runs when plugged into any electric power supply, including generators. Based on the design of our patented planetary gear reduction system, the **RAD® V SERIES** offers a smooth continuous flow of controlled torque which is adjustable through dial settings.

- ✓ **Quick adjust torque settings**
Fast and accurate "dial a torque" for maximum versatility and efficiency
- ✓ **Soft-start vary speed trigger**
Allows operator to safely and quickly set reaction arm before full torque is applied
- ✓ **Equal power in forward and reverse**
Convenience and cost effective use of same tool for break away and final torque
- ✓ **Advanced ultra-durable electric motor design**
Extreme duty designed to reduce maintenance cost and increase reliability

Maximum versatility and efficiency...



All V-RAD tools come fully calibrated complete with:

- V-RAD Tool
- Reaction Arm and Retention Ring
- Operators manual
- Calibration Chart
- Weatherproof Storage Case

V SERIES DIMENSIONS

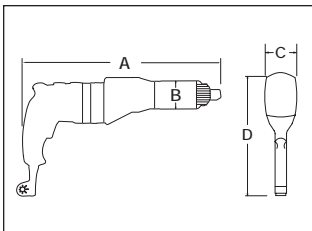

PART NUMBER	TOOL MODEL	DRIVE SIZE	TORQUE (ft. lbs.)		WEIGHT (lbs.)	DIMENSION A	DIMENSION B	DIMENSION C	DIMENSION D
			LOW	HIGH					
13497	V-RAD 4	0.75"	100	400	10.0	17.0"	2.5"	3.0"	8.5"
12899	V-RAD 10	0.75"	300	1000	11.0	18.0"	2.5"	3.0"	8.5"
12389	V-RAD 16	1.0"	500	1600	15.0	19.0"	3.0"	3.0"	8.5"
13501	V-RAD 23	1.0"	800	2300	15.0	19.5"	3.0"	3.0"	8.5"

Visit our website for a complete up-to-date list of products.

REACTION ARM SELECTION CHART



* weldable

* weldable

TOOL SERIES	STANDARD <i>(Included with tool)</i>	DEEP SOCKET	DOUBLE ENDED ARM	BLANK	DOUBLE ENDED BLANK
RAD 350	10686	10687	10688	10036	10037
RAD 550SL	14900	15923	15924	10036	10037
RAD 800	10043	10458	10459	10044	10045
RAD 1400/1800	10004	10007	10009	10005	10008
RAD 30	10022	10025	10027	10024	10026
RAD 50	10039	10401	10403	10040	10402
RAD 7/10GX	13366	13367	13368	13364	13365
RAD 25GX	10514	10515	10516	10513	10448
RAD 34GX	11531	11534	11533	11530	11532
RAD 85GX	12885	13508	13509	13505	13506
RAD 1400/1800GX-R	13484	13515	13516	13513	13514
RAD 7GX-R	13512	12902	13442	13773	12903

*Reaction arms not exactly as shown (7GX-R, 1400GX-R, 1800GX-R)

B-RAD 350	10686	10687	10688	10036	10037
B-RAD 700	13366	13367	13368	13364	13365
B-RAD 1300	10514	10515	11533	11530	11532
E-RAD 700	13366	13367	13368	13364	13365
E-RAD 1200	10004	10007	10009	10005	10008
E-RAD 2000	10247	10395	10397	10394	10396
E-RAD 3000	11531	11534	11533	11530	11532
E-RAD 4000	10039	10401	10403	10040	10402
V-RAD 4	10686	10687	10688	10036	10037
V-RAD 10	13366	13367	13368	13364	13365
V-RAD 16	10004	10007	10009	10005	10008
V-RAD 23	10514	10515	10516	10513	10448

** Please contact us if you have a specific or custom application.
Our Engineering Department can design a reaction arm for all of your needs.
www.radtorque.com*

Sample of Custom Reaction Arms shown below



NOSE EXTENSION SELECTION CHART



Part Number	Description	Dimension A	Dimension B	Dimension C	Dimension D
10257	RAD 1800NG 15" Nose Extension	5"	16"	2"	3.5"
10258	RAD 1800NG 18" Nose Extension	5"	18"	2"	3.5"
10259	RAD 1800NG 12" Nose Extension	5"	12.7"	2"	3.5"
12087	RAD 30 12" Nose Extension	5"	12.8"	2"	3.25"
10734	RAD 30 15" Nose Extension	5"	15.8"	2"	3.25"
10735	RAD 30 18" Nose Extension	5"	18.8"	2"	3.25"
12061	RAD 25GX 15" Nose Extension	5"	16"	2"	3.25"
12096	RAD 25GX 12" Nose Extension	5"	13"	2"	3.25"
12097	RAD 25GX 18" Nose Extension	5"	18.5"	2"	3.25"
14195	RAD 10GX 12" Nose Extension	N/A	12.75"	2.5"	N/A
14200	RAD 10GX 15" Nose Extension	N/A	15.75"	2.5"	N/A
14205	RAD 10GX 18" Nose Extension	N/A	18.75"	2.5"	N/A

10GX Nose Extensions require a reaction arm. Refer to 7GX-R Reaction Arms on previous charts.

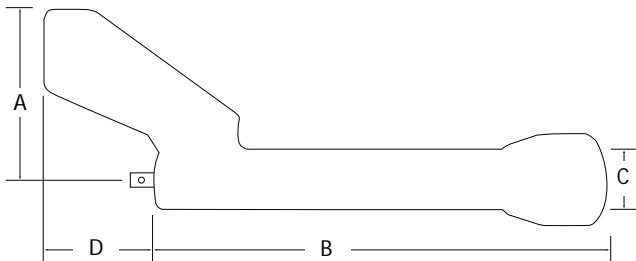

RAD 10GX (12818), 12" nose extension (14195), with reaction arm (13512)

RAD CALIBRATION SYSTEMS

ACCESSORIES



Part Number
10787

RCA-5000
Torque Range 500-5000ft/lb
Accuracy +/- .25%



Part Number
10786

RCA-3000
Torque Range 300-3000ft/lb
Accuracy +/- .25%



Part Number
10785

RCA-1000
Torque Range 100-1000ft/lb
Accuracy +/- .25%

ELECTRONIC SERIES

All E Series tools come fully calibrated complete with:

- E-RAD Tool
- Reaction Arm and Retention Ring
- Controller cables
- Digital Torque Controller
- Operators manual
- E-RADCAL Calibration Software

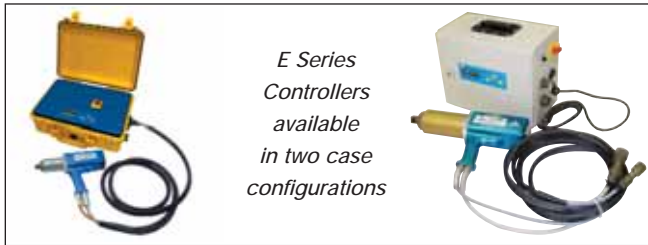

E Series
Controllers
available
in two case
configurations

E-RAD Controller with torque controls and digital display enclosed in a weatherproof case for harsh environments.

E-RAD Controller with upright heavy duty steel case, top mounted torque controls and digital display.

BATTERY SERIES

All B-RAD tools come fully calibrated complete with

- B-RAD Tool
- Reaction Arm and Retention Ring
- Two 18 volt batteries
- Battery charger
- Calibration Chart
- Storage Case



B-RAD TOOL KIT

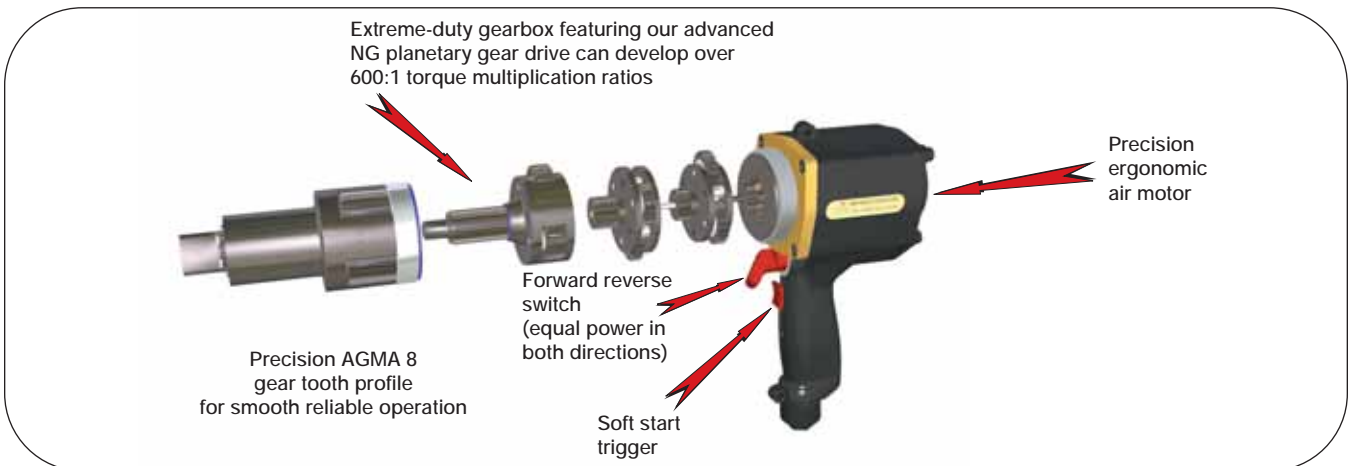

RAD® pneumatic torque wrenches incorporate our PATENTED Planetary Gear Reduction Drive Systems to produce the highest power-to-weight ratio of any pneumatic controlled bolting system in the world today!

15 YEARS INCORPORATED



New World Technologies Inc. is a leading Canadian manufacturer of pneumatic, battery powered, and electronic pistol grip torque wrenches. Our advanced products have proven to be successful all over the world in such industries as oil and gas, petrochemical, mining, aerospace, and manufacturing. We continue to invest in and employ the latest technology to achieve the highest level of innovation, quality, and performance - which has resulted in multiple patents for our products. New World Technologies Inc. has designed its operations for maximum flexibility and responsiveness ensuring our customers receive outstanding service.



- 14 CNC machining centers (Okuma and HAAS systems)
- CAD and CAM processing (Solid Works and Master Cam)
- 9 gear cutting machines (working to AGMA standards)
- 3 Professional Engineers (Mechanical and Electronics)

MAXIMUM FLEXIBILITY AND RESPONSIVENESS, ENSURING OUR CUSTOMERS RECEIVE OUTSTANDING SERVICE



Power



Highest Power-to-Weight ratio of any power tool

All RAD[®] torque guns are designed to deliver the highest power-to-weight ratio of any pneumatic tool on the market today, saving you time and money in maintenance or production costs. The extremely high torque and constant rotation make our tools ideal for virtually any bolting application you will encounter. Equal power in both forward and reverse allows more diversity for tough maintenance jobs.



Accuracy



Accuracy +/-5%, repeatability 2%*

Every RAD[®] air torque wrench is individually calibrated and traceable to NIST standards to help ensure joint integrity. Our tools are many times more accurate than impact wrenches and in many cases can be more precise than click type manual torque wrenches, which are often over pulled by operators.
* With correct air supply



Safety



88 times less vibration than Impact wrenches...Operates at only 85 db

RAD[®] torque guns are one of the safest power tools on the market today. Our exclusive low profile reaction arm takes virtually all the operational load off the operator, reducing injuries and greatly reducing operating costs. Don't wait for a time loss injury or legislation to force change in your environment, RAD[®] guns set the standard in bolting safety.



www.radtorque.com
1-800-983-0044

COMPANY PROFILE

LIGHTER • FASTER • STRONGER

Believe It!



**MINING
OIL & GAS
AEROSPACE
PETROCHEMICAL
MANUFACTURING**

Pneutool Parts Service Co. Ltd.

33 Haas Road, Toronto, On M9W 3A1

Tel: 416-748-1200

Toll Free: 1-888-748-1201

Fax: 416-748-2695

E-mail: sales@pneutool.com



**NEW WORLD
TECHNOLOGIES
INCORPORATED**

www.radtorque.com